

V340

VENUS series Lockshield Valves

FOR THE RETURN PORT OF RADIATORS, EXTERNAL THREADS

PRODUCT DATA

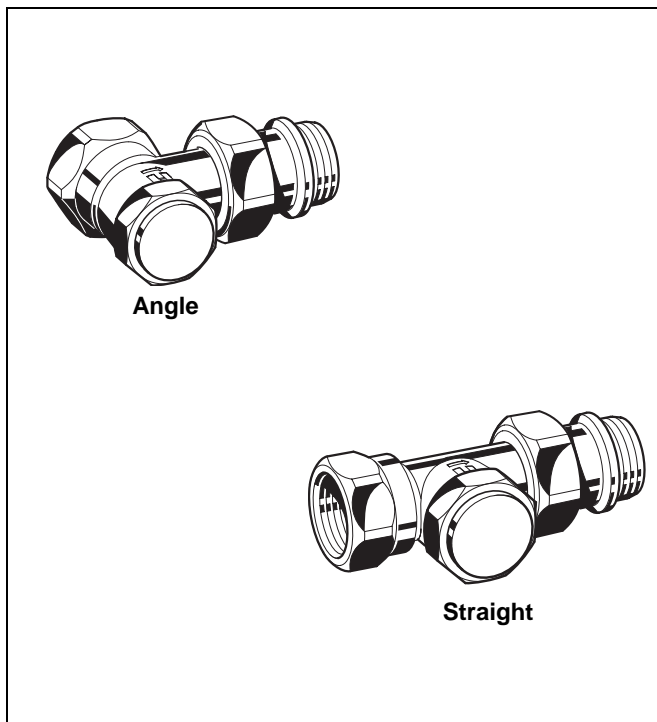

Application

VENUS series lockshield valves are used to connect radiators and other heat exchangers to heating circuits of hydronic heating systems. They are installed at the return port of the radiator and offer a shutoff function to separate the radiator from the heating circuit, for example for renovating.

Features

- With shutoff function for easy removal of connected radiator
- Connection to all types of pipework DN10 to DN15
- Tail piece with integrated O-ring

Specifications

Medium	Heating water, water quality to VDI2035
ph-value	8...9,5
Operating temperature	max. 120°C (248°F)
Operating pressure	PN 10
Differential pressure	max. 0.20 bar (2.9 psi) recommended for quiet operation

Design

The lockshield valves consist of:

- Valve housing PN10, DN10 or DN15 with
 - internal thread connection to ISO228 on inlet
 - external thread connection with union-nut and radiator tail-piece on outlet
 - angle and straight bodies with dimensions according to EN215, Appendix A, Series F
- Valve insert
- Protection cap
- Union-nut and radiator tailpiece

Materials

- Valve housing made of nickel-plated brass
- Valve insert made of brass with EPDM O-rings and soft seals and stainless steel spindle
- Protection cap made of grey plastic
- Union-nut and tailpiece made of nickel plated brass with EPDM O-ring

Dimensions and Ordering Information

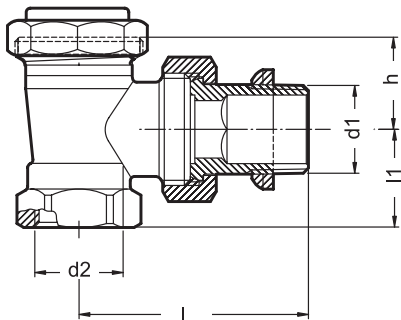

Fig. 1. Angle version

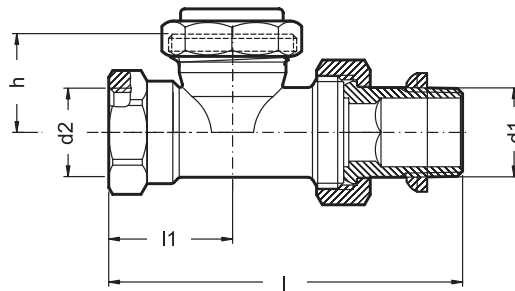

Fig. 2. Straight version

Table 1. Available versions and OS-Nos (OS=Ordering System)

Versions	DN	Dimensions					OS-No.
		d1	d2	l1	l	h	
Angle (Fig. 1)	10	Rp 3/8"	Rp 3/8"	20	49	21.5	V340E010
	15	Rp 1/2"	Rp 1/2"	23	53	21.5	V340E015
Straight (Fig. 2)	10	Rp 3/8"	Rp 3/8"	25	75	23	V340D010
	15	Rp 1/2"	Rp 1/2"	29	82	23	V340D015

NOTE: All dimensions in mm unless stated otherwise.

Please Note:

- To avoid stone deposit and corrosion the composition of the medium should conform with VDI-Guideline 2035
- Additives have to be suitable for EPDM sealings
- System has to be flushed thoroughly before initial operation with all valves fully open
- Any complaints or costs resulting from non-compliance with above rules will not be accepted by Honeywell
- Please contact us if you should have any special requirements or needs

Accessories



Connections

Compression ring and nut

	1/2" x 10 mm	VA620A1510
	1/2" x 12 mm	VA620A1512
	1/2" x 14 mm	VA620A1514
	1/2" x 15 mm	VA620A1515
	1/2" x 16 mm	VA620A1516



NOTE: Support inserts have to be used for copper or soft steel pipe with 1.0 mm wall thickness

Compression ring and nut with support insert (2 pcs each)

	1/2" x 12 mm	VA621A1512
	1/2" x 15 mm	VA621A1515
	1/2" x 16 mm	VA621A1516

NOTE: Support inserts have to be used for copper or soft steel pipe with 1.0 mm wall thickness

Compression ring and nut with support insert for composite pipe (2 pcs each)

	1/2" x 14 mm	VA622B1514
	1/2" x 16 mm	VA622B1516

Flow Diagram

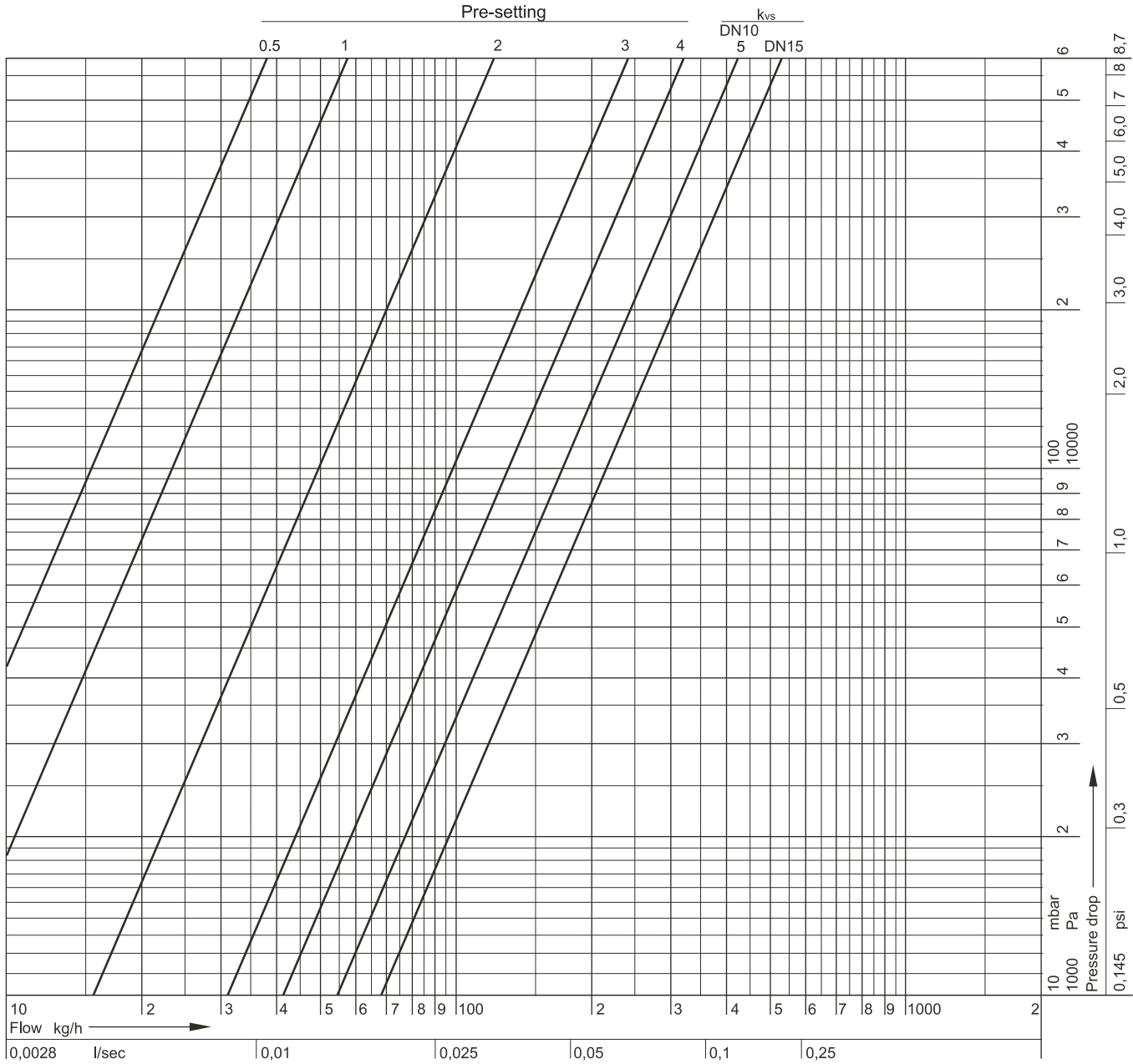

Automation and Control Solutions

Honeywell GmbH

Hardhofweg

74821 Mosbach, Germany

Phone: +49 (6261) 810

Fax: +49 (6261) 81393

www.honeywell.com

EN0H-2205GE25 R1106
November 2006

© 2006 Honeywell International Inc.
Subject to change • All rights reserved

Manufactured for and on behalf of the Environmental and Combustion
Controls Division of Honeywell Technologies Sàrl, Ecublens,
Route du Bois 37, Switzerland or by its Authorized Representative.

Honeywell